



product_datasheet_title

DL SLIM SQ 210 18 W 4000 K WT

DOWNLIGHT SLIM SQUARE | Flat downlights with integrated driver, square shape



technical_data

ELECTRICAL DATA

Nominal wattage	18.00 W
Nominal voltage	220...240 V
Mains frequency	50...60 Hz
Nominal current	108 mA
Inrush current	17 A
Inrush current time T_{h50}	56 μ s
Max. number of luminaires per miniature circuit breaker B16	44
Max. number of luminaires per miniature circuit breaker C10	35
Max. number of luminaires per miniature circuit breaker C16	56
Power factor λ	0.50
Total harmonic distortion	< 20 %
Protection class	II
Operating mode	Integrated LED driver

PHOTOMETRICAL DATA

Luminous flux	1530 lm
Luminous efficacy	85 lm/W
Color temperature	4000 K
Light color (designation)	Cool White
Color rendering index Ra	> 80
Standard deviation of color matching	< 6 sdc _m
Luminous intensity	-
Flickering metric (Pst LM)	-
Stroboscope effect metric (SVM)	-
Photobiological safety group acc. to EN62778	RG0
Photobiological safety group acc. to EN62471	RG0
Beam angle	120 °

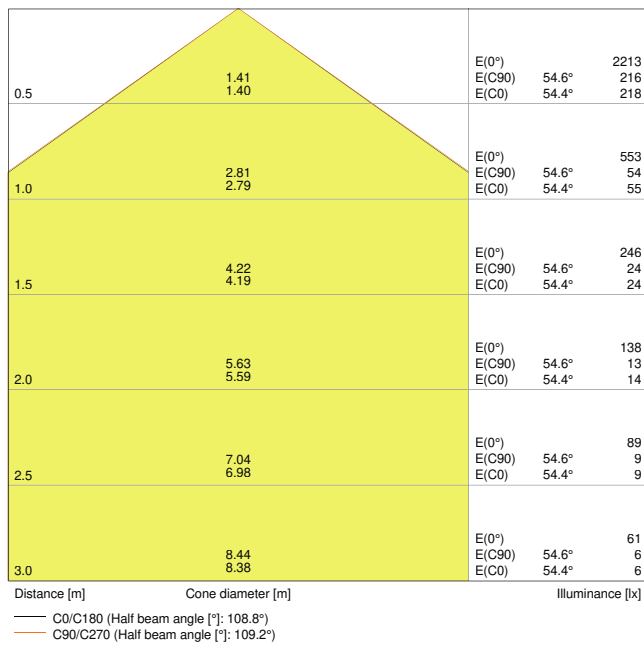

4058075052604 DL SLIM SQ210 18W 4000K WT IP20

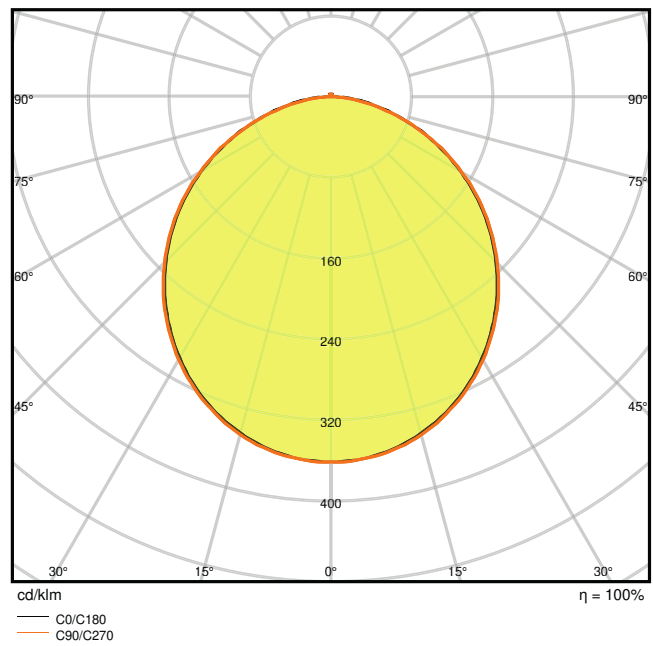

4058075052604 DL SLIM SQ210 18W 4000K WT IP20

DIMENSIONS & WEIGHT

Length	225.00 mm
Width	225.00 mm
Height	30.00 mm
Product weight	527.00 g

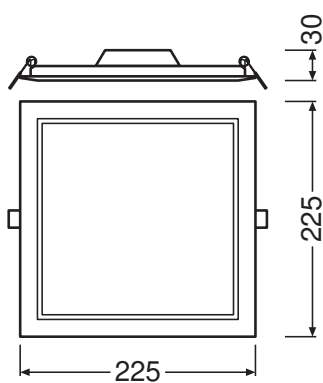

DL Slim SQ210 18W

MATERIALS & COLORS

Product color	White
Housing color	White
Body material	Polycarbonate (PC)
Cover material	Polycarbonate (PC)
Light emitting surface material	Polycarbonate (PC)
Glow Wire Test according to IEC 60695-2-12	650 °C
Mercury content	0.0 mg

APPLICATION & MOUNTING

Ambient temperature range	-20...+50 °C
Temperature range at storage	-30...+70 °C
Type of connection	Screwless terminal, 2-Pole
Type of protection	IP20
Protection class IK (shock resistance)	IK03
Dimmable	no
Mounting type	Recessed
Mounting location	Ceiling / Wall
Application environment	Indoor
Mounting length	210,0 mm
Mounting width	210,0 mm
Mounting depth	50,0 mm
LED module replaceable	Not replaceable
With light source	Yes

LIFESPAN

Lifespan L70/B50 at 25 °C	30000 h ¹⁾
Lifespan L80/B10 at 25 °C	20000 h ¹⁾
Lifespan L90/B10 at 25 °C	12000 h
Number of switching cycles	50000

¹⁾ t[h]: L70 / B50 @ 25 °C (Ta), t[h]: L80 / B10 @ 25 °C (Ta), t[h]: L90 / B10 @ 25 °C (Ta)

CONTROL GEAR

Output current	295 mA
ECG - Output ripple current	< 6.5 %



CERTIFICATES & STANDARDS

Standards	CE / CB / EAC
Luminaire with limited surface temperature, "D sign"	No
Ball shot safe	No







ADDITIONAL PRODUCT DATA







Number of illuminants	Not relevant
-----------------------	--------------

Accessories Optional

product_image	product_name	product_ean
	DL SLIM FRAME SQ 210 WT	4058075052680
	DL SLIM FRAME SQ 210 WT	4058075079434

download_data

Documents and certificates		document_name
	Addon Technical Information	LSI DL SLIM
	Installation guide	User Instruction Downlight LED Slim
	On-Pack-Info	Legal Insert Downlight Slim
	Declarations Of Conformity CE	CE Certificate downlight Slim
	Declarations Of Conformity UKCA	DL SLIM WT IP20
Photometric and lighting design files		document_name
	IES file (IES)	DL SLIM SQ210 18W 4000K WT IP20
	LDT file (Eulumdat)	DL SLIM SQ210 18W 4000K WT IP20

Photometric and lighting design files		document_name
	ULD file (DIALux)	DOWNLIGHTSLIMSQUARE21018W4000KWT
	ROLF file (RELUX)	DL SLIM SQ210 18W-4000K
	UGR file (UGR table)	4058075052604 DL SLIM SQ210 18W 4000K WT IP20
	LDC typ cone	4058075052604 DL SLIM SQ210 18W 4000K WT IP20
	LDC typ polar	4058075052604 DL SLIM SQ210 18W 4000K WT IP20
CAD/BIM files		document_name
	CAD_STEP_3D	DL SLIM SQ 210

logistical_data

product_code	packaging_unit	dimensions	weight	volume
4058075079359	Folding box 1	45 mm x 250 mm x 230 mm	610.00 g	2.59 dm ³
4058075079366	Shipping box 6	290 mm x 260 mm x 250 mm	3991.00 g	18.85 dm ³

logistical_data_text

disclaimer_title

disclaimer_text